



Product Information

## Axio Zoom.V16

High Resolution and High Speed:  
Your Zoom Microscope for Large Fields.

INTERNET-LINK 

VIDEO/ANIMATION 

Release 1.0



We make it visible.

## Faster results. More information.

### Axio Zoom.V16

High Resolution and High Speed: Your Zoom Microscope for Large Fields.

---

#### > In Brief

---

> The Advantages

---

> The Applications

---

> The System

---

> Technology and Details

---

> Service

---

Axio Zoom.V16, the apochromatic on-axis zoom microscope by Carl Zeiss, delivers both high resolution and a zoom range of 16x. With its large working distance and a single objective, you will be zooming seamlessly from large object fields to the smallest detail. Large tile-images at low to medium magnification rates are a special strength, enabling you to enjoy the speed and ease of auto-mated stitching. The objective aperture of Axio Zoom.V16 is big compared to stereomicroscopes and leads to resolution rates that are clearly better, particularly at low to medium magnification. Imaging is a lot faster: Capture images more efficiently and speed up your quantitative analyses.

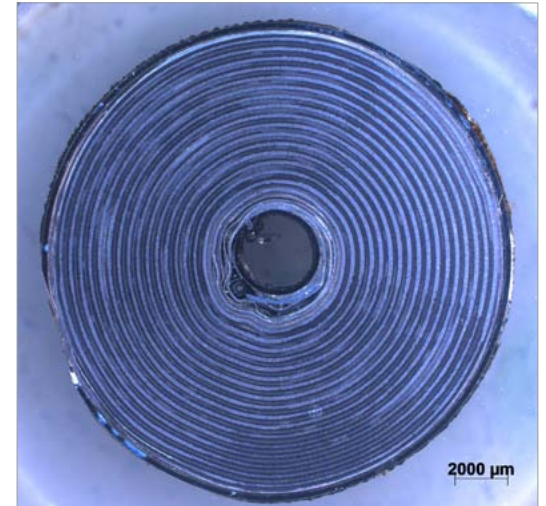

# Axio Zoom.V16: simpler, more intelligent, more integrated.

## Axio Zoom.V16

High Resolution and High Speed: Your Zoom Microscope for Large Fields.

- › In Brief
- › **The Advantages**
- › The Applications
- › The System
- › Technology and Details
- › Service

## Zoom between minute detail and large object fields.

Your Axio Zoom.V16 combines its 16x zoom with a high numerical aperture and large working distance: even at low and medium magnifications you will achieve resolutions up to twice as high as with conventional stereomicroscopes. Don't waste your time stitching tile-images: now you can image entire components with just a few shots. Work up to four times faster, achieve results in a more effective way and reduce sources of error.

## The zoom microscope that's made for your application.

Axio Zoom.V16 works with a motor-driven iris so you can select the ideal mode for your application at the touch of a button. Brightness Mode captures your images with the highest possible intensity across the whole zoom area. Use Eyepiece Mode when you want to analyze your samples visually through the Axio Zoom.V16 eyepiece. Zoom from large object fields with a maximum depth of field in high magnifications, achieving the highest possible resolution. In Camera Mode, your Axio Zoom.V16 automatically matches the resolution to the performance of your camera. Throughout the whole zoom range, Axio Zoom.V16 chooses the best ratio between resolution and depth of field.

## EpiRel produces a relief-like image contrast.

The EpiRel slider in the Epi-Illuminator Z of your Axio Zoom.V16 produces an impressive effect in coaxial incident light when you slightly incline the illumination to produce a relief-like image contrast. Now you will discover textures and small ridges, particularly at high magnification. Objects will take on more contour than in conventional brightfield.

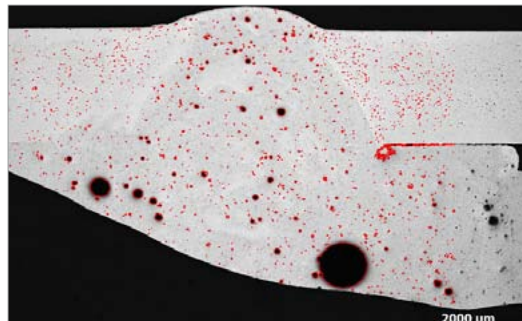

# Your insight into the technology behind it

## Axio Zoom.V16

High Resolution and High Speed: Your Zoom Microscope for Large Fields.

- › In Brief
- › **The Advantages**
- › The Applications
- › The System
- › Technology and Details
- › Service

### eZoom produces images with more precision

The zoom body or 'pancrat' is the core of stereo and zoom microscopes. While zooming, it uses a motor drive to position the lenses of your Axio Zoom.V16 individually, achieving extreme precision.

### Now eZoom images are twice as sharp

With Axio Zoom.V16, eZoom replaces the mechanical curve with an electronic one. Each zoom body describes its own zoom curve and captures visibly more details.

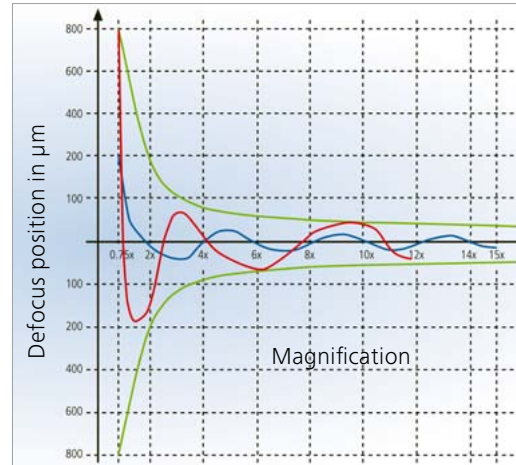

- Depth of field curve; images are in focus within these parameters
- Typical defocus curve of a single zoom channel with mechanical zoom curve
- Typical defocus curve of a single zoom channel with electronic zoom curve

The defocus curve shows it clearly: eZoom follows the base line for image sharpness over the magnification range with twice the precision of a mechanical zoom body.



When the micro clapper of the computer controlled glue leveling machine brings eZoom's lens in the zoom body into position...

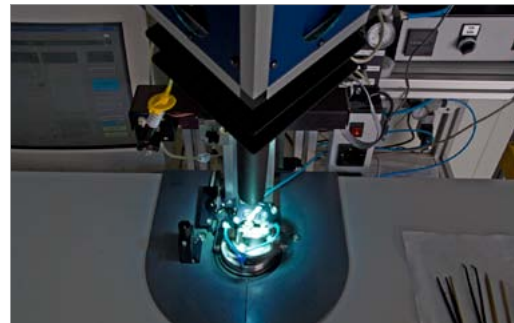

...it is glued and cured with UV light.



The zoom body adjustment device calculates the zoom control curve from around 7,000 reference points.

# Tailored precisely to your applications

## Axio Zoom.V16

High Resolution and High Speed: Your Zoom Microscope for Large Fields.

- .....
- › In Brief
- .....
- › The Advantages
- .....
- › **The Applications**
- .....
- › The System
- .....
- › Technology and Details
- .....
- › Service
- .....

Typical applications, typical samples	Task	Axio Zoom.V16 offers
<b>Scanner Component</b>	Fast imaging and measurement of large components with high resolution to analyze structure details statistically	Imaging of large components with low and medium magnification and high image quality. Homogenous coaxial illumination for high quality capture of large MosaiX images.
<b>Materialography</b>	Materialographic routine analysis of standard materials, quantitative and qualitative structural analysis, resolution of fine structures	Highly detailed image information even with low-to-medium magnification of complex material structures owing to the large numeric aperture
<b>Microelectronics/electronics - e.g. wafers</b>	Reproducible inspection of wafer and mask surface structures, regarding process errors, impurities and defects	<p>Continuous change from overview to enlarged detail</p> <p>Destruction-free evaluation and measuring of structures within micrometers - with 99% reproducibility thanks to electronic zoom curve</p> <p>Relief-like image contrast even for flat samples using the EpiRel slider in the Epi-Illuminator Z</p>
<b>Forensic analysis - e.g. projectile cases</b>	Imaging and documentation of instrumentalities and traces with high-resolution images	<p>Continuous change from overview to enlarged detail</p> <p>Reproducibility of 99% thanks to electronic zoom curve</p> <p>Reduction of reflexes in coaxial illumination</p> <p>Precise EDF images thanks to high resolution and low depth of field</p> <p>Documentation with AxioVision and AxioCam</p>

## Axio Zoom.V16 at Work

### **Axio Zoom.V16**

High Resolution and High Speed: Your Zoom Microscope for Large Fields.

- › In Brief
- › The Advantages
- › **The Applications**
- › The System
- › Technology and Details
- › Service

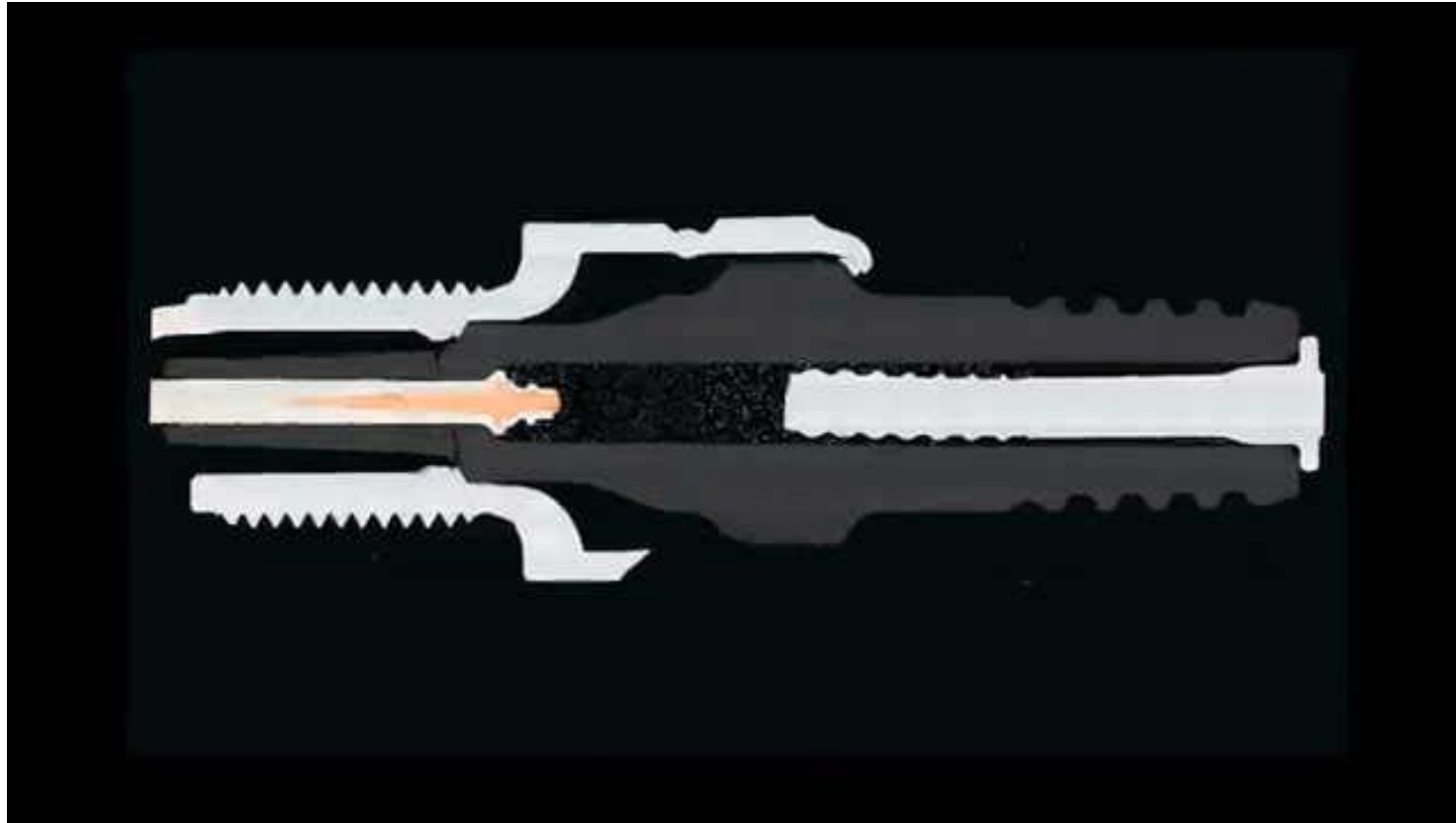

*Spark plug: zoom from an overview to the smallest detail without changing objective.*

## Axio Zoom.V16 at Work

### Axio Zoom.V16

High Resolution and High Speed: Your Zoom Microscope for Large Fields.

- › In Brief
- › The Advantages
- › **The Applications**
- › The System
- › Technology and Details
- › Service

With Axio Zoom.V16, you have an overview of entire components. Then, magnified 50 times, the geometric architecture of the electrodes becomes visible.

You will see details such as the layer thickness of the active material, arresters and separators. Use these detailed insights to draw conclusions about manufacturing defects.

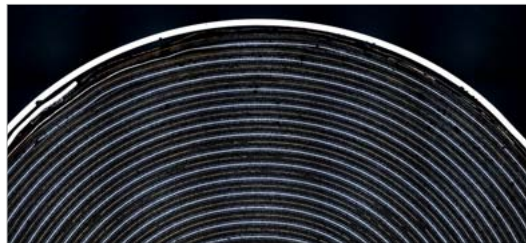

*Lithium ionic accumulator, brightfield*

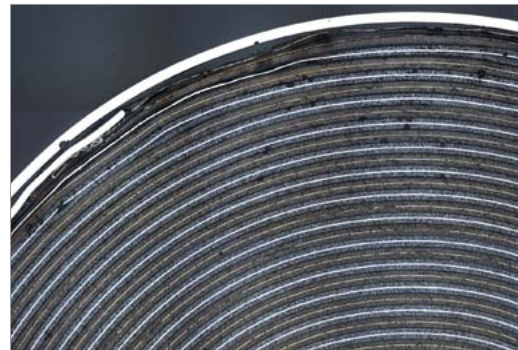

*Lithium ionic accumulator, 50x, brightfield*

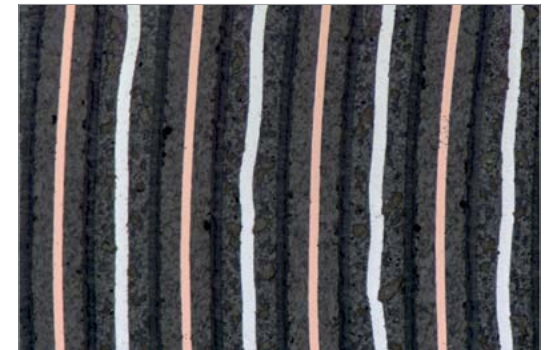

*Lithium ionic accumulator, 112x, brightfield*

During forensic analyses, examine traces that lie deep in projectile cases. Thanks to the high resolution of your Axio Zoom.V16, you will capture them in every detail.

The coaxial incident light minimizes reflections. You can document even the faintest traces with great reliability. Use the software module Extended Depth of Focus (EDF) to produce an image covering the entire thickness of your specimen – EDF processes sharp images full of details out of several focal planes.

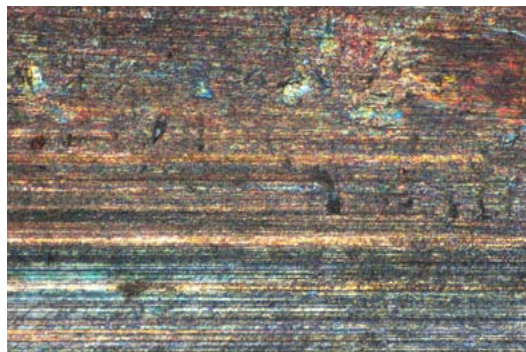

*Projectile case, 42x, EDF*

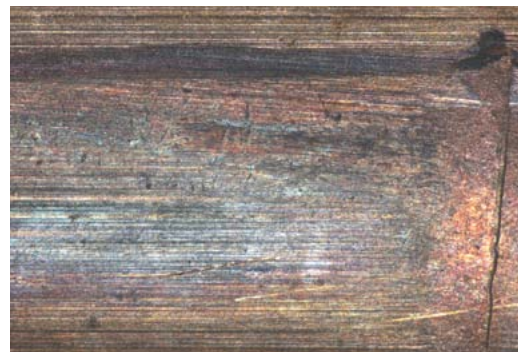

*Projectile case, 112x, EDF*

# Axio Zoom.V16: Your Flexible Choice of Components

## Axio Zoom.V16

High Resolution and High Speed: Your Zoom Microscope for Large Fields.

› In Brief

› The Advantages

› The Applications

› **The System**

› Technology and Details

› Service

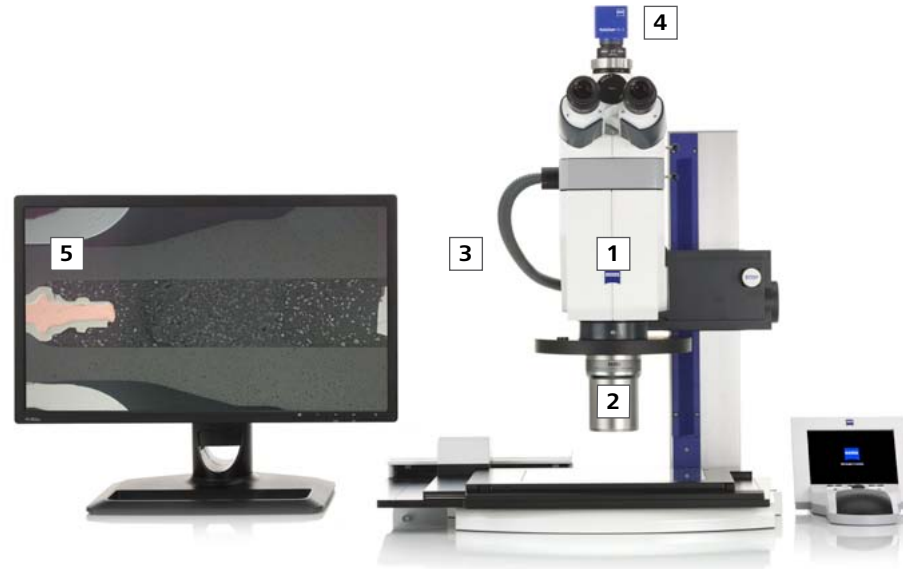

### 1 Microscope

- Axio Zoom.V16 (manual focus)
- Axio Zoom.V16 (focus motor)

### 2 Objectives

- PlanApo Z 0.5x/0.125 FWD 114
- PlanApo Z 1.0x/0.25 FWD 60
- Apo Z 1.5x/0.37 FWD 30
- PlanNeoFluar Z 1.0x/0.25/ FWD 56
- PlanNeoFluar Z 2.3x/0.57/ FWD 10.6

### 3 Illumination

Cold light sources CL 1500 Eco, CL 6000 LED, CL 9000 LED CAN with fiber optic spot, annular, linear, vertical, diffuser, area illumination and Epi-Illuminator Z

LED annular lights with segmenting function  
Fiber optic and LED transmitted light systems  
HXP 200 C with Fluar-Illuminator Z

### Illumination techniques:

Brightfield, darkfield, oblique light, polarization, fluorescence

### 4 Cameras

Recommended cameras:

AxioCam HRc, AxioCam MRc5, AxioCam ICc5

### 5 Software

Recommended AxioVision modules:

- MosaiX (image acquisition scanning stage)
- Extended Focus (calculation of a sharp image from several focus planes)
- Interactive Measurement (expanded interactive measurement techniques)
- Online Measurement (interactive measurement in live image)



# Axio Zoom.V16: System Overview

## Axio Zoom.V16

High Resolution and High Speed: Your Zoom Microscope for Large Fields.

> In Brief

> The Advantages

> The Applications

> The System

> Technology and Details

> Service

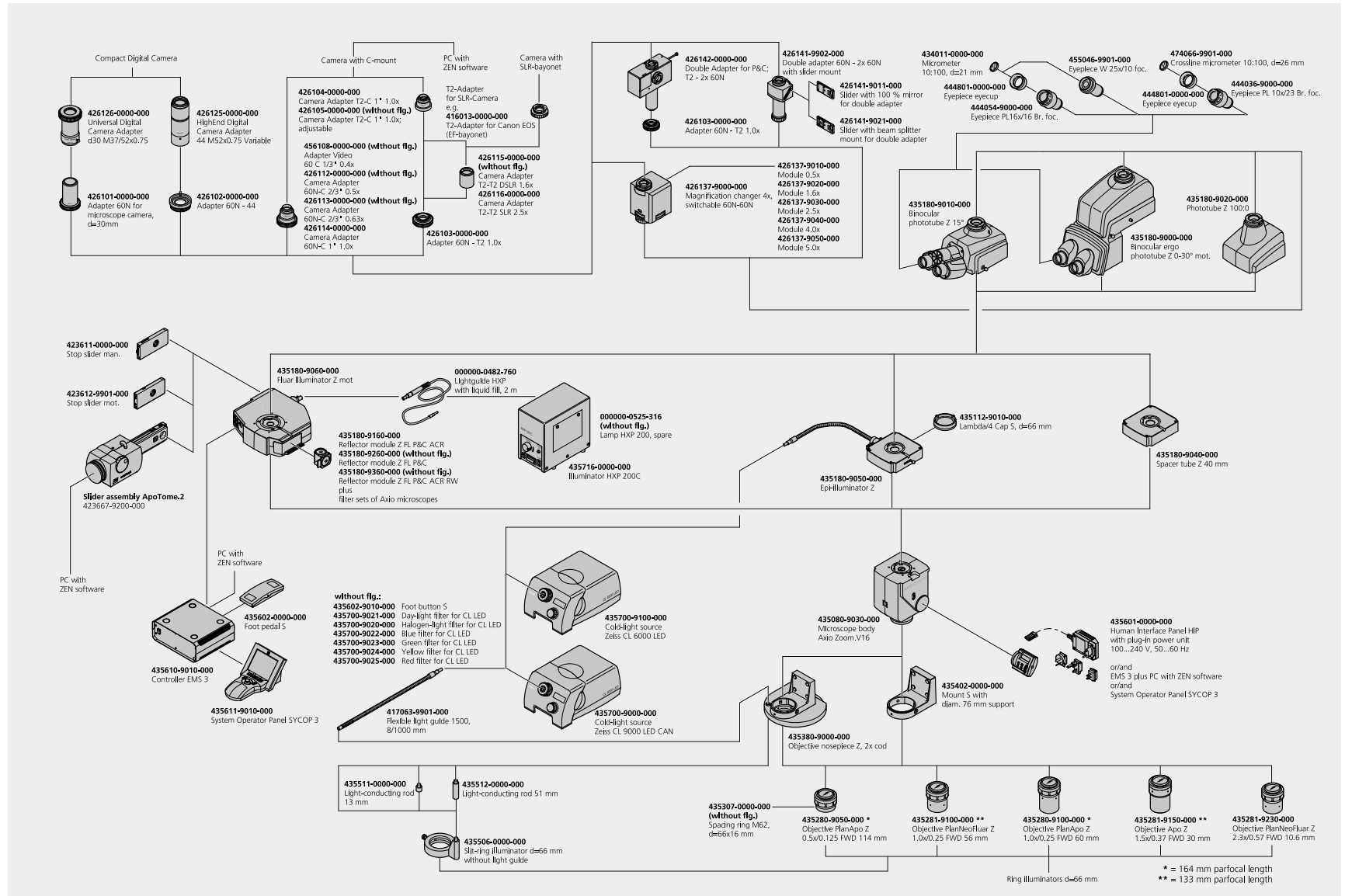

# Axio Zoom.V16: System Overview

## Axio Zoom.V16

High Resolution and High Speed: Your Zoom Microscope for Large Fields.

- › In Brief
- › The Advantages
- › The Applications
- › The System
- › Technology and Details
- › Service

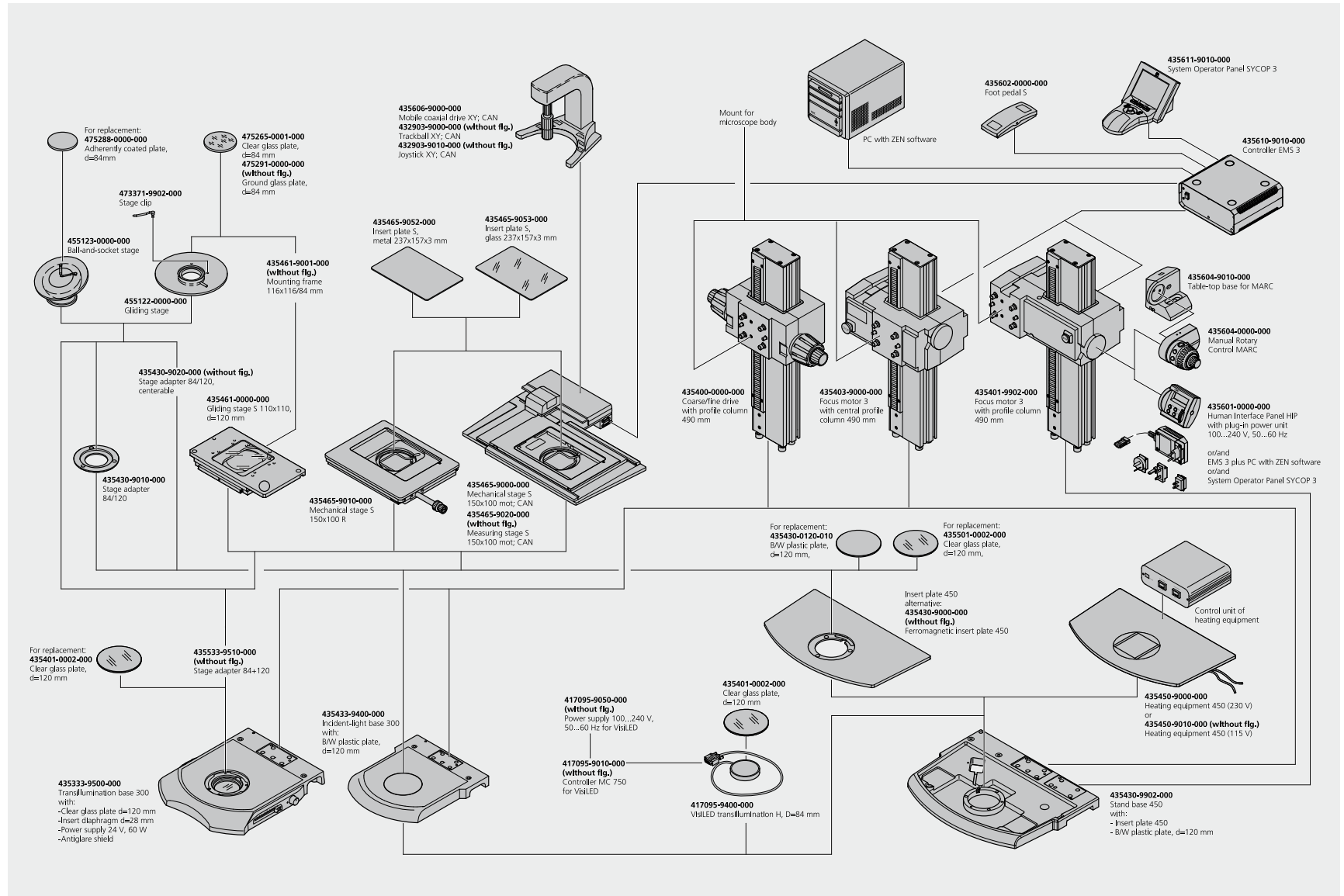

# Axio Zoom.V16: System Overview

## Axio Zoom.V16

High Resolution and High Speed: Your Zoom Microscope for Large Fields.

### In Brief

### The Advantages

### The Applications

### The System

### Technology and Details

### Service

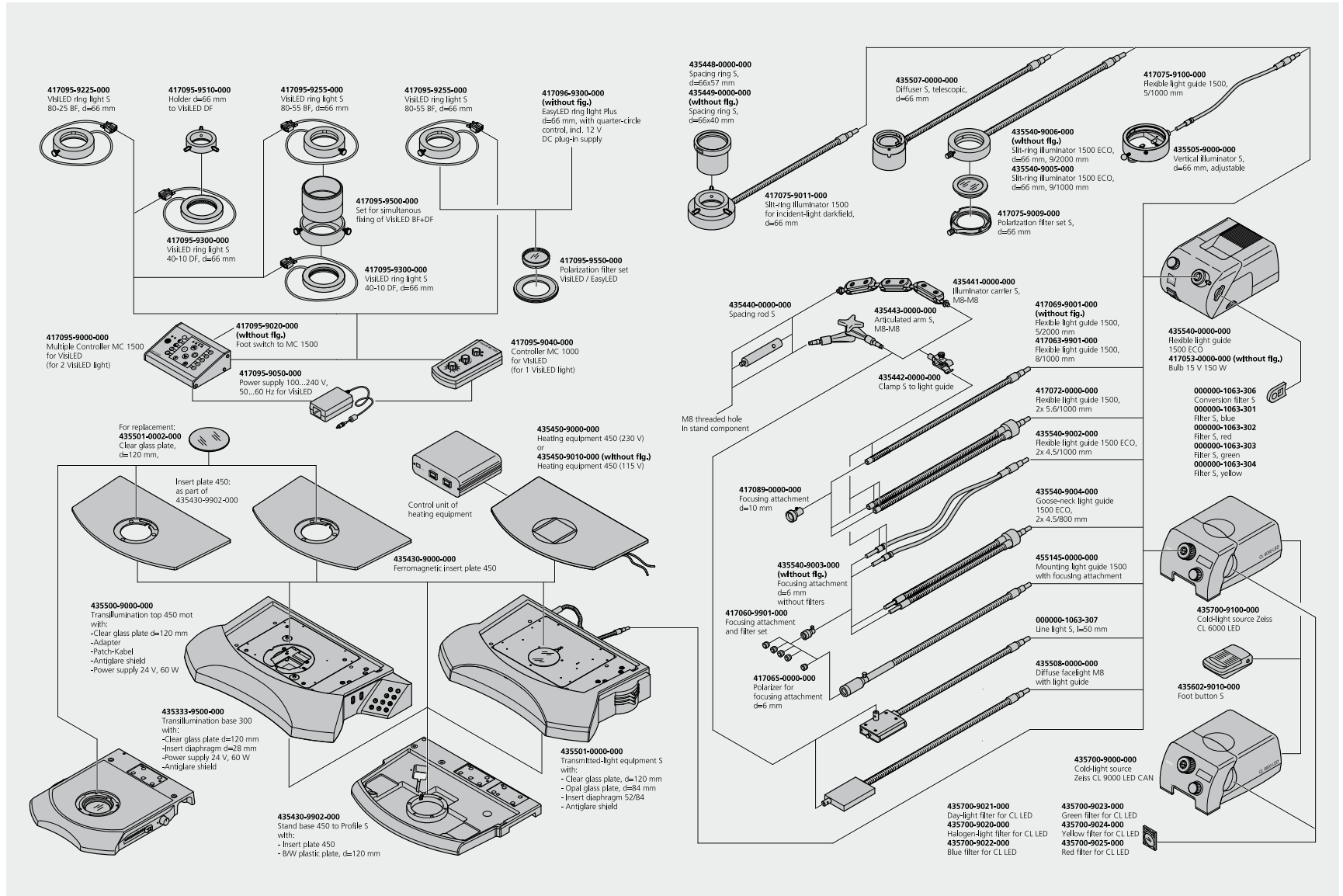

# Technical Specifications

## Axio Zoom.V16

High Resolution and High Speed: Your Zoom Microscope for Large Fields.

- › In Brief
- › The Advantages
- › The Applications
- › The System
- › **Technology and Details**
- › Service

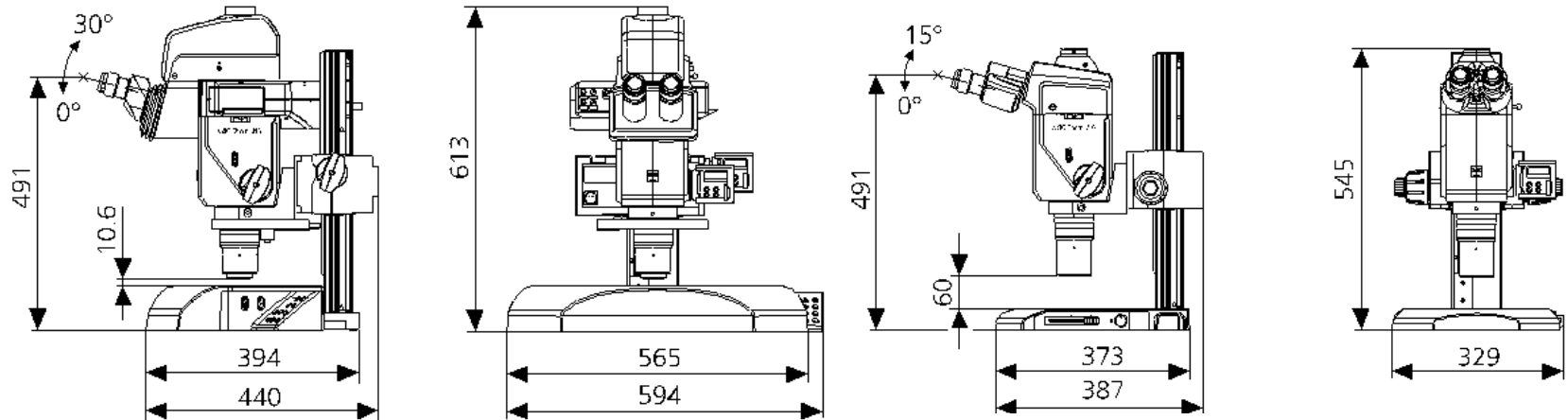

Objective	Eyepiece PL 10x/23		Eyepiece PL 16x/16			
	Factor	FWD <sup>1)</sup> in mm	Magnification	Object field (mm)	Magnification	Object field (mm)
PlanApo Z*	0.5x	114	3.5 ... 56x	66 ... 4.1	5.6x ... 90x	46 ... 2.9
PlanApo Z*	1.0x	60	7x ... 112x	33 ... 2.0	11x ... 179x	23 ... 1.4
Apo Z**	1.5x	30	10.5 ... 168x	22 ... 1.4	17 ... 269x	15 ... 0.95
PlanNeoFluar Z**	1.0x	56	7x ... 112x	33 ... 2.0	11x ... 179x	23 ... 1.4
PlanNeoFluar Z***	2.3x	10.6	16x ... 258x	14 ... 0.9	26x ... 412x	9.9 ... 0.6

1) FWD - Free Working Distance  
 \* Parfocal length 164 mm  
 \*\* Parfocal length 133 mm  
 \*\*\* Transfer length 105 mm

# Technical Specifications

## Axio Zoom.V16

High Resolution and High Speed: Your Zoom Microscope for Large Fields.

- › In Brief
- › The Advantages
- › The Applications
- › The System
- › **Technology and Details**
- › Service

### Microscope

Stand	Axio Zoom.V16 (manual focus)	Axio Zoom.V16 (focus motor)
Dimensions (W x D x H)	329 mm x 545 mm x 387 mm	594 mm x 613 mm x 440 mm
Weight	≥ 22 kg	≥ 33.6 kg

### Illumination

Cold light sources CL 1500 Eco, CL 6000 LED, CL 9000 LED CAN with fiber optic spot, ring, linear, vertical, diffuser, area illumination and Epi-Illuminator  
 VisiLED ring lights with segmenting function  
 Fiber optic and LED transmitted light systems  
 HXP 200 C with Fluar-Illuminator Z

### Illumination techniques

Brightfield, darkfield, oblique light, polarization, fluorescence

### Operational data

#### Plug-in power supply as a component of HIP

Electrical protection class	II
Ingress protection rating	IP 40
Mains voltage (wide range)	100 to 240 V ±10 %
Mains frequency	50 to 60 Hz
Power consumption	700 mA
Output voltage	stabilized 24 V DC, 1.25 A, 30 W
RFI suppression	acc. to EN 55011 Class A
Noise immunity	acc. to DIN EN 61326-1
Electrical Safety	acc. to DIN EN 61010-1 (IEC 61010-1) allowing for CSA and UL specifications

#### Tabletop power supply unit for transmitted light illumination

Mains voltage (wide range)	100 to 240 V ±10 %
Mains frequency	50 to 60 Hz
Power consumption	1.4 A

# Technical Specifications

## Axio Zoom.V16

High Resolution and High Speed: Your Zoom Microscope for Large Fields.

- › In Brief
- › The Advantages
- › The Applications
- › The System
- › **Technology and Details**
- › Service

### Focusing drive

Movement range	340 mm
Maximum sample height (including stage and a parfocalized objective) with the use of:	
Nosepiece	200 mm
Carrier with 76 mm holder, bottom	205 mm
Carrier with 76 mm holder, top	300 mm
Reduction of maximum specimen height by transmitted light unit S	55 mm
Stroke per turn of manual focusing drive:	
Coarse focusing drive 350	27.6 mm
Coarse focusing drive 500	27.6 mm
Fine focusing drive 350	2.2 mm
Fine focusing drive 500	2.8 mm
Step size of motorized focusing drive	0.35 $\mu$ m

### Environmental conditions

Storage (in packaging)	
Permissible ambient temperature	+10 to +40 °C
Permissible relative air humidity (no condensation)	max. 75 % at 35 °C

# Technical Specifications

## Axio Zoom.V16

High Resolution and High Speed: Your Zoom Microscope for Large Fields.

- › In Brief
- › The Advantages
- › The Applications
- › The System
- › **Technology and Details**
- › Service

### Transport (in packaging)

Permissible ambient temperature	-40 to +70 °C
---------------------------------	---------------

### Operation

Permissible ambient temperature	+10 to +40 °C
---------------------------------	---------------

Permissible relative air humidity (no condensation)	max. 75 %
---	-----------

Atmospheric pressure	800 hPa to 1060 hPa
----------------------	---------------------

Pollution degree	2
------------------	---

Area of use	Closed spaces
-------------	---------------

Highest permitted altitude of use	max. 2000 m
-----------------------------------	-------------

# Technical Specifications

## Axio Zoom.V16

High Resolution and High Speed: Your Zoom Microscope for Large Fields.

- › In Brief
- › The Advantages
- › The Applications
- › The System
- › **Technology and Details**
- › Service

### SYCOP 3 / EMS 3

#### Dimensions (W x D x H)

SYCOP 3	160 mm x 260 mm x 125 mm
EMS 3	250 mm x 220 mm x 105 mm

#### Weight

SYCOP 3	0.6 kg
EMS 3	3 kg

#### Power supply

SYCOP 3	via MDR 2x20 cable from EMS 3
EMS 3	100 V AC to 240 V AC, 50 Hz/60 Hz

#### Operational data

Area of use	Closed spaces
Protection class	I
Protection type	IP 20
Electrical safety	acc. to DIN EN 61010-1 (IEC 61010-1) allowing for CSA and UL specifications
Overvoltage category	II
Radio interference suppression	as specified in EN 55011 Class A
Noise immunity	as specified in DIN EN 61326-1
AC line voltage range	100 V AC to 240 V AC $\pm$ 10 %
Line frequency	50 Hz to 60 Hz
Power consumption of EMS 3	180 VA
Fuse protection of EMS 3	2x T 4 A/H 250 V



# Technical Specifications

## Axio Zoom.V16

High Resolution and High Speed: Your Zoom Microscope for Large Fields.

- › In Brief
- › The Advantages
- › The Applications
- › The System
- › **Technology and Details**
- › Service

### Environmental conditions

#### Transport (in packaging)

Permissible ambient temperature	-40 to +70 °C
---------------------------------	---------------

#### Storage (in packaging)

Permissible ambient temperature	-40 to +70 °C
Permissible relative air humidity (no condensation)	max 75 % at 35 °C

### Operation

Permissible ambient temperature	+5 °C to +35 °C
Permissible relative air humidity (no condensation)	maximal 75 % at 35 °C
Area of use	Closed spaces
Pollution degree	2
Highest permitted altitude of use	maximal 2000 m
Atmospheric pressure	800 hPa to 1,060 hPa

### Optical Risk Group Classification According to DIN EN 62471:2009

HXP 200 C	Risk group 1 according to DIN EN 62471:2009
CL 9000 LED	LED risk group 1 according to DIN EN 62471:2009
Transillumination top 450 mot	LED risk group 1 according to DIN EN 62471:2009
Transillumination base 300	LED risk group 1 according to DIN EN 62471:2009

### Radiating Apertures

Microscope systems with:	
HXP 200 C, CL 9000 LED	From the objective vertically upward
Transillumination top 450 mot	From transmitted-light attachment vertically upward
Transillumination base 300	From transmitted-light base vertically upward

# Service Backup for Those Moments of Inspiration

## Axio Zoom.V16

High Resolution and High Speed: Your Zoom Microscope for Large Fields.

- › In Brief
- › The Advantages
- › The Applications
- › The System
- › Technology and Details
- › **Service**

Because the Carl Zeiss microscope system is one of your most important tools, we make sure it is always ready to perform. What's more, we'll see to it that you are employing all the options that get the best from your microscope. You can choose from a range of service products, each delivered by highly qualified Carl Zeiss specialists who will support you long beyond the purchase of your system. Our aim is to enable you to experience those special moments that inspire your work.

### **Repair. Maintain. Optimize.**

Attain maximum uptime with your microscope. A Carl Zeiss maintenance contract lets you budget for operating costs, all the while avoiding costly downtime and achieving the best results through the improved performance of your system. Choose from service contracts designed to give you a range of options and control levels. We'll work with you to select the service program that addresses your system needs and usage requirements, in line with your organization's standard practices.

Our standard preventative maintenance and repair on demand contracts also bring you distinct advantages. Zeiss service staff will analyze any problem at hand and resolve it – whether using remote maintenance software or working on site.

### **Enhance Your Microscope System**

Your Carl Zeiss microscope system is designed for a variety of updates: open interfaces allow you to maintain a high technological level at all times. As a result you'll work more efficiently now, while extending the productive lifetime of your microscope as new update possibilities come on stream.

Please note that our service products are always being adjusted to meet market needs and may be subject to change.



*Profit from the optimized performance of your microscope system with a Carl Zeiss service contract – now and for years to come.*

[www.zeiss.com/microservice](http://www.zeiss.com/microservice)

The moment “I think” becomes “I know”.  
**This is the moment we work for.**

**Axio Zoom.V16**

High Resolution and High Speed: Your Zoom Microscope for Large Fields.

- › In Brief
- › The Advantages
- › The Applications
- › The System
- › Technology and Details
- › Service

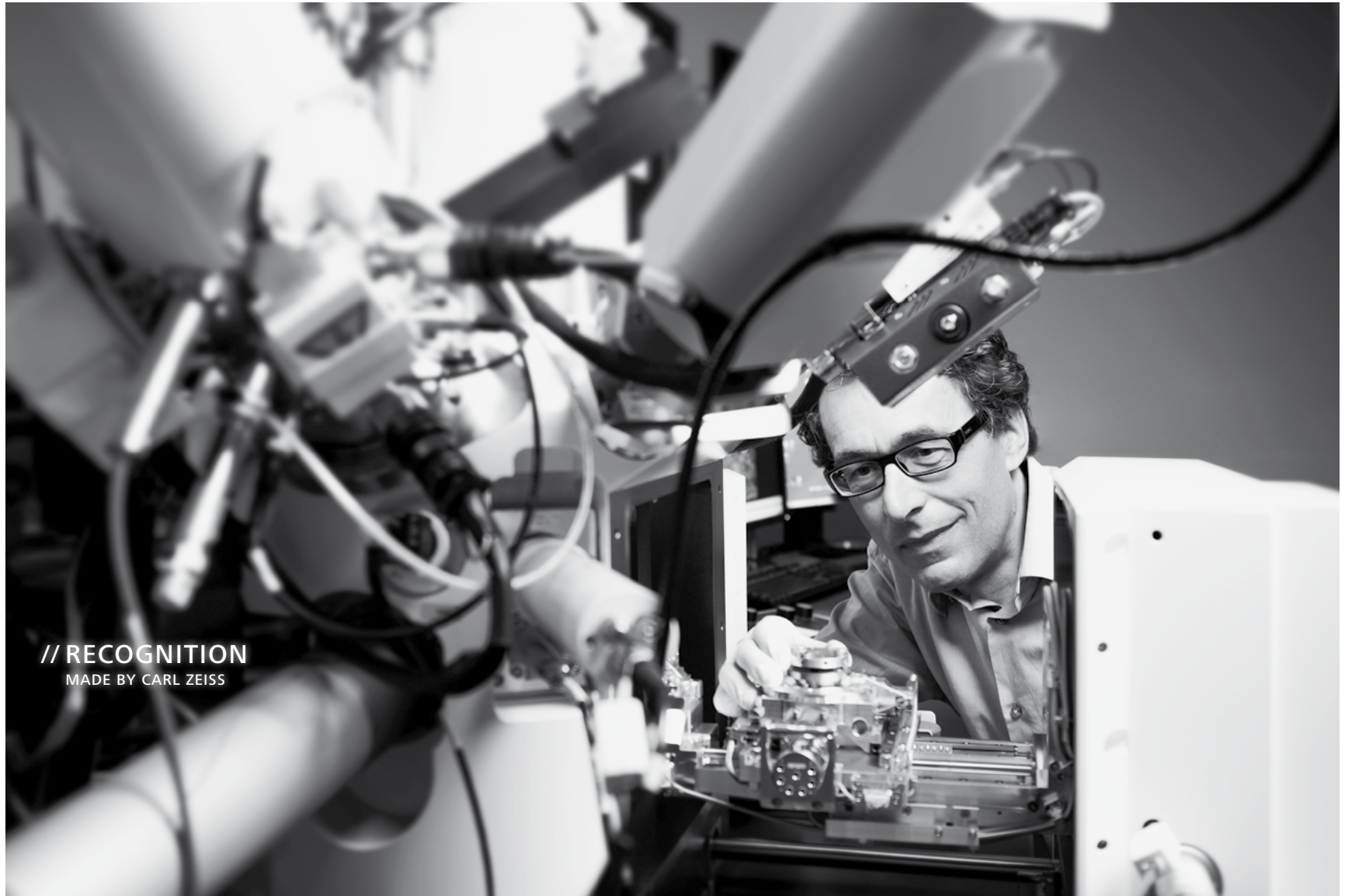

// RECOGNITION  
MADE BY CARL ZEISS

## Axio Zoom.V16

High Resolution and High Speed: Your Zoom Microscope for Large Fields.

- › In Brief
- › The Advantages
- › The Applications
- › The System
- › Technology and Details
- › Service



[facebook.com/zeissmicroscopy](https://facebook.com/zeissmicroscopy)



[twitter.com/zeiss\\_micro](https://twitter.com/zeiss_micro)



[youtube.com/zeissmicroscopy](https://youtube.com/zeissmicroscopy)



[flickr.com/zeissmicro](https://flickr.com/zeissmicro)



### Carl Zeiss Microscopy GmbH

07745 Jena, Germany

Materials

[microscopy@zeiss.com](mailto:microscopy@zeiss.com)

[www.zeiss.com/axiozoom-mat](http://www.zeiss.com/axiozoom-mat)



We make it visible.